



UNIVERSAL COLOR Paperless Recorder

—Max. 10 Channels, 96X96mm—

Model No.: MPR800



General Specifications

GS 19A16D01-02EN

PAPERLESS RECORDER

UNIVERSAL INPUT

MPR800

Overview

MPR800 is universal color paperless recorder, max 10 channels, high accuracy, universal use, easy operation, to be aimed to display, measurement the processes parameters such as temperature, humidity, pressure, flow, vibration etc in various industry application.

Feature

- High accuracy: $\pm(0.2\%FS + 1)$ digit, 3.5" TFT LCD display
- Programmable universal input: T.C., RTD, mA, VDC, mV
- Input channels no.: 1, 2, 3, 4, 5, 6, 7, 8, 9, 10 channels
- Built in thermocouple automatic cold junction compensation
- Output: 4-20mA, relay, 24VDC auxiliary power supply
- RS485 communication port, standard MODBUS-RTU protocol, configurable with HMI, SCADA, OPC serve etc.
- Flow totalize with temperature, pressure compensation
- Match Function: +, -, x, /, average, max, mini
- Various curve, barograph, digit for different type display
- Strong PC software to display data in digital curve, Print and export to excel for further analysis
- Wide power supply: 100-240VAC; 24VDC



MPR800 Universal Color Paperless Recorder
96x96x100mm, up to 10 channels

Memory Flash Data Saving, Various Screen Display, Easy operation

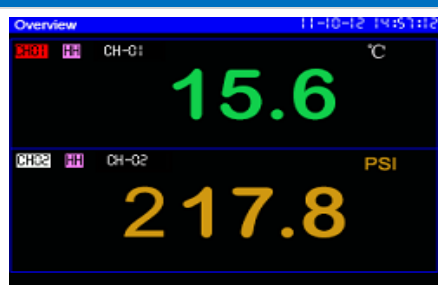

Digital Display 2 Channels/screen

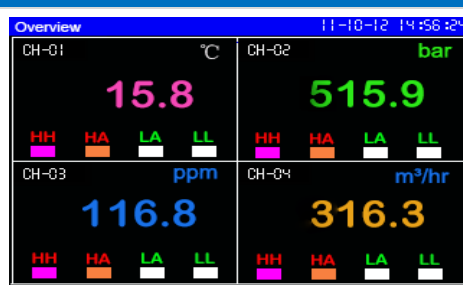

Digital Display 4 Channels/screen



Digital Display 8 Channels/screen

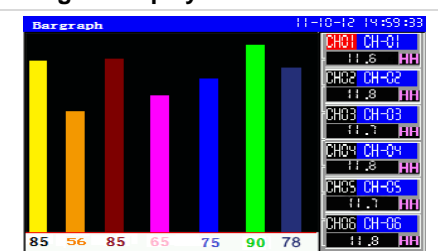

Digital & Barograph Display

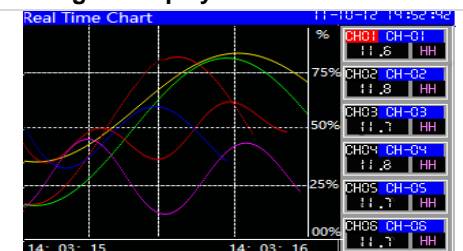

Digital & Curve Display



Digital & Circular Chart Display

Memory Flash Drive Data Saving

Provides flexibility and variety in the handling of record data

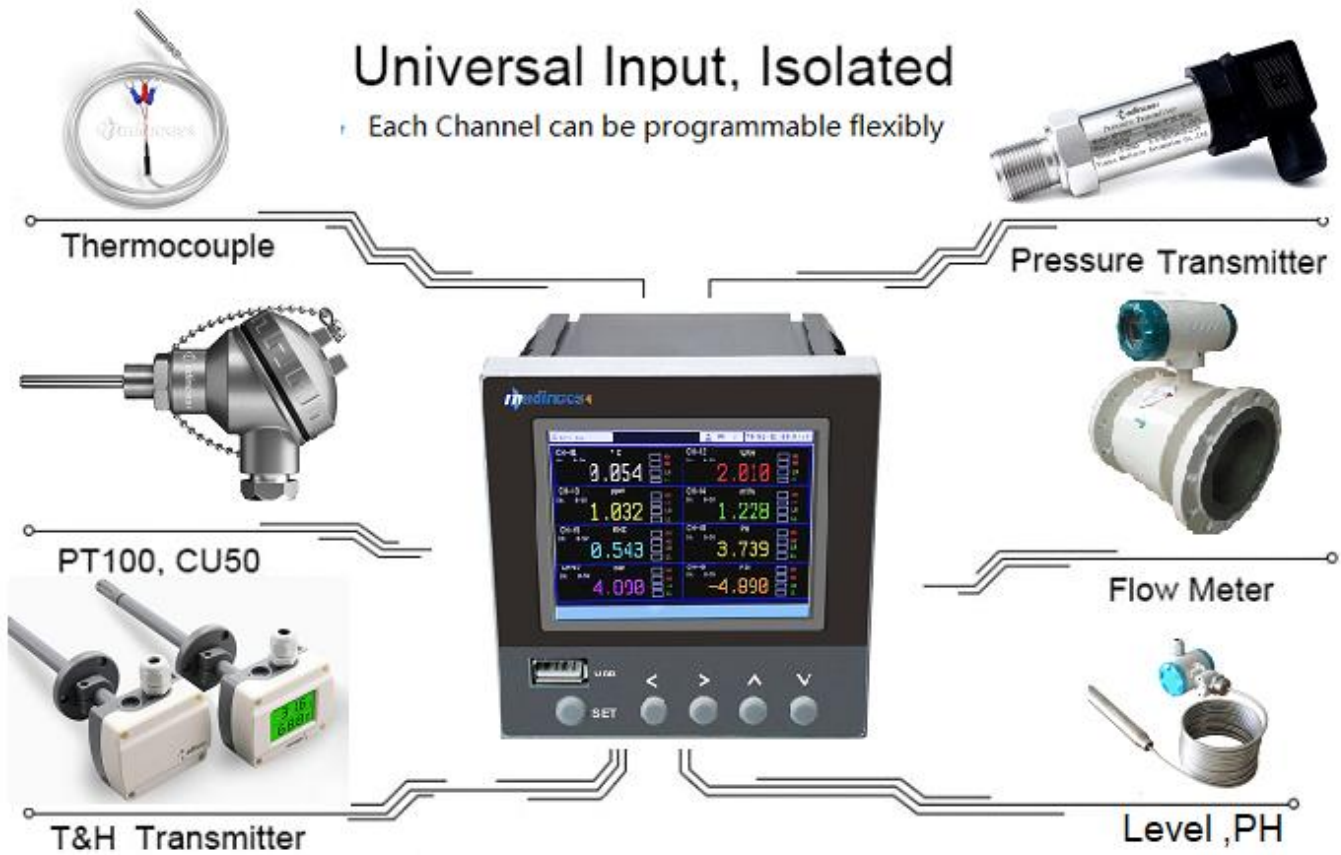

USB Pen Driver for data Transfer

Configuration with SCADA, PLC, HMI, OP sever

USB Pen Driver for Data Transfer

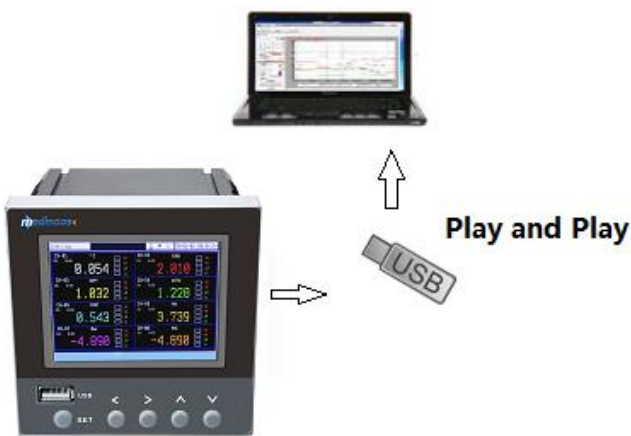

Free 8GB USB pen driver and PC software for data transferring to PC, plug and play, easy to operation, data transferred automatically within some minutes when u need to transfer data and insert pen driver

Real Time Reading and Monitoring

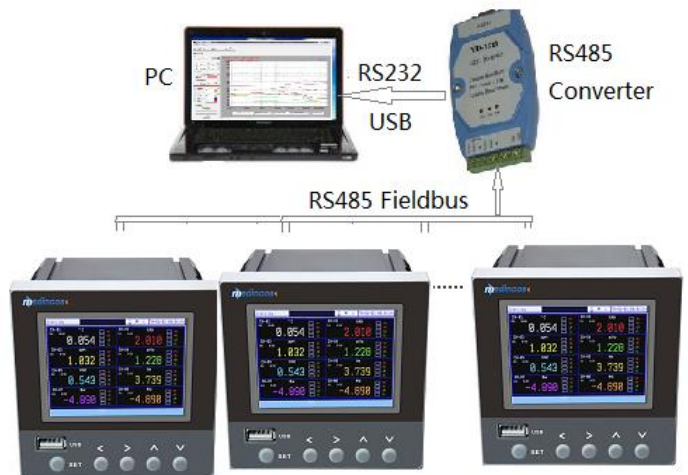

Standard RS485 MODBUS-RTU protocol, configurable with SCADA, DCS, PLC, HMI, OPC server for real time reading and monitoring in control room remotely, Baud rate: 9600 default, 4800, 19200, RS485 is reading and writing functions

Dimension (mm)

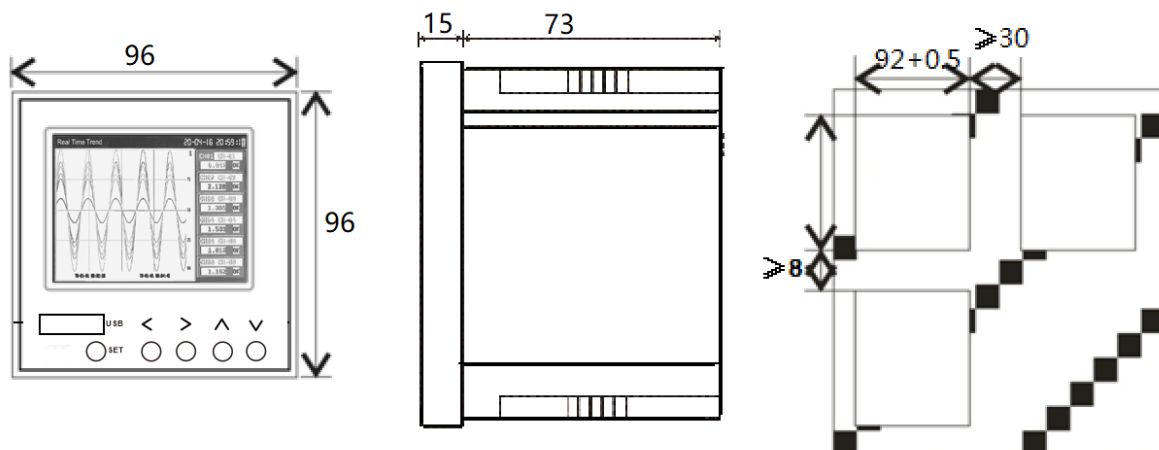

Diagram

a. When input channels no. >5, without retransmission

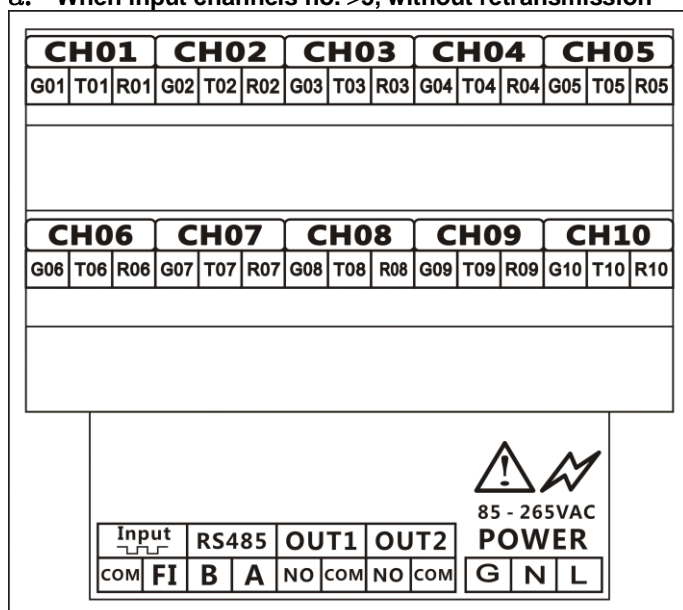

b. when input channels no. <=5, retransmission output <= 2

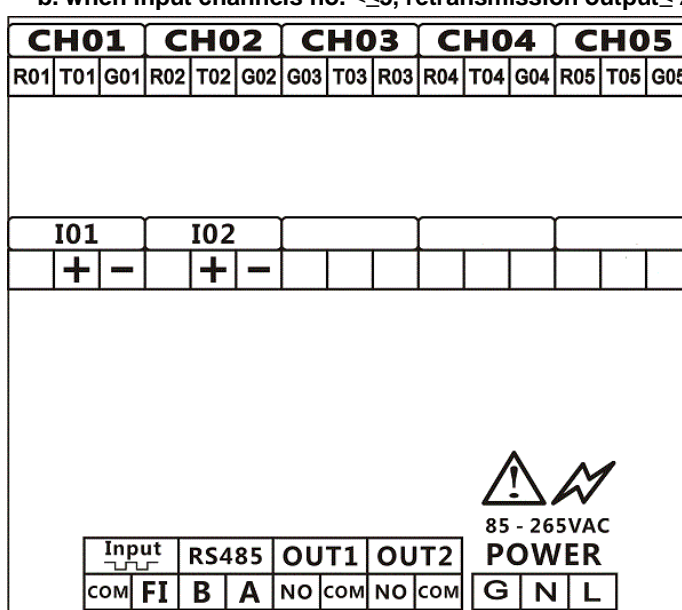

Note: When 4-20ma input, please connect 50ohm resistor in parallel connection in input terminals

When 0-10ma input, please connect 500ohm resistor in parallel connection in input terminals

PC Software

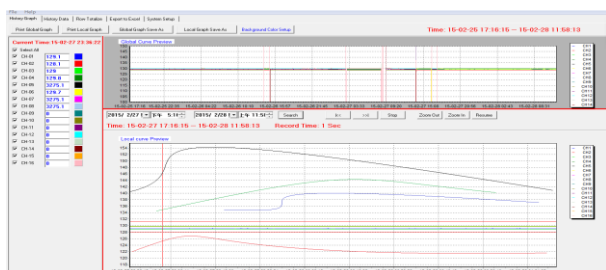

PC Software for USB Data Transferring, free when ex-work

Used for history data checking and further analysis

- . History Data will be displayed in digit and trend
- . History Data can be exporting the data as Excel for further analysis
- . History Data can be printed in the curve by printer directly
- . Flow Totalizer data display in shift, weekly, monthly

Suitable for PC Version: Window 2000/XP, VISTA, Win7, 8, 10

Installation: Please copy our software in your PC directly

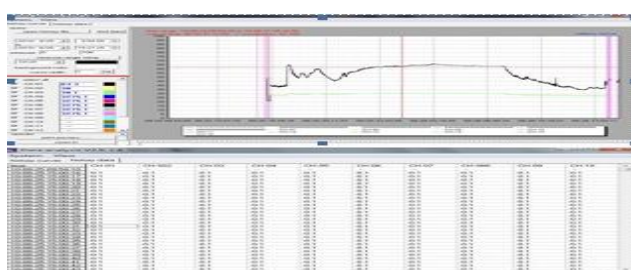

DCS Software for RS485 Communication, option

Used for real time monitoring & reading while data memory

- . Data in will be displayed in digit and curve
- . History Data can be exporting the data as Excel for further analysis
- . History Data can be printed in the curve by printer directly

Suitable for PC Version: Window 2000/XP, VISTA, Win7, 8, 10

Installation: Please copy our software to your PC directly

■ Specification

Input		Input				
Input No.	1, 2,3, 4,5,6,7,8, 9,10	Input Type	Measured Range	Input Independence		
Thermocouple Input	K, J, T, E,R,S,B,N,Wre526,Wre325	RTD	Pt100	-200 to 600°C	>20MΩ	
RTD Input	Pt100, CU50, CU100		CU50	-50 to150°C	>20MΩ	
Analog Input	4-20mA, 0-10mA, 0-5V, 1-5V, 0-10VDC		CU100	-50 to150°C	>20MΩ	
mV Input	0–20mV,0-60mV, 0-100mV, 0-500mV	T.C	K	-50 to 1300°C	>20MΩ	
Frequency input	0-5KHZ; 0-50hz; 0-500hz; 1 Channel		J	0 to 1000°C	>20MΩ	
Isolation	photoelectric isolation		T	-200 to 350°C	>20MΩ	
Accuracy	± (0.2%FS +1) digital		E	0 to 800°C	>20MΩ	
Resolution	0.1°C when temperature input		R	-50 to 1700°C	> 20MΩ	
Sample time	1 second per 8 channels		S	-50 to 1700°C	> 20MΩ	
Decimal No.	0-4 programmable; 1 when temperature		B	300 to 1800°C	>20MΩ	
T.C. cold compensation	Built- in auto. Compensation		N	0 to 1300°C	>20MΩ	
Compensation Tolerance	Max.±1°C		Wre526	0-2300°C	>20MΩ	
Channel-GND Isolation	1000VAC		Wre325	0-2300°C	>20MΩ	
Channels 'Isolation	400VAC	Analog	4-20mA	-20000 to 20000	250 Ω	
Temperature shift	50PPM		0-10mA	-20000 to 20000	500Ω	
CMR Ratio	85-110dB		0-5VDC	-20000 to 20000	500KΩ	
T.C. wire resistor	Less than 1000Ω		1-5VDC	-20000 to 20000	500KΩ	
RTD wire resistor	max1000Ω per wire, should same each wire		0-10VDC	20000 to 20000	500KΩ	
Inner CPU	32bits ARM CPU, high performance		mV	0-60mV	-20000 to 20000	>20MΩ
Hardware watchdog	CPU inner integration for long-term stability			0-100mV	-20000 to 20000	>20MΩ
Memory			Display			
Memory Capacity	90days x Record Interval Time/CH numbers		LCD Size	3.5” color TFT LCD		
Record interval time	1-3600seconds, programmable by key		LCD Resolution	320x240 TFT color LCD		
Channel Numbers	1,2,3,4,5,6,7,8,9,10 CH numbers	Display interval	1-3600 seconds, set flexibly			
Memory type	NOR Flash memory	Data Display Type	Digit, curve, barograph, chart;			
Data transfer Media	8GB USB pen driver, plug and play;	Background	50,000hours (lifespan)			
Transferred data file	16MB, all data in recorder transferred	Screensaver	0-30,000second, set flexibly			
Data File Name	Year/month/Day/Address.dat: 19031801.dat	Engineer unit	°C, %, psi,bar,m3/hr, ppm.....programmable			
Full capacity memory	earliest data replaced by newest data	Resolution	32 Bit AD inner, final resolution:16 bit			
Data Format	Binary format or cannot read or write	Display	5 digits; Flow totalize:11 digits			
Outputs (Option)		Others				
Relay	Max. 2 outputs, programable	Power Supply	100-240VAC, 47-63Hz; 24VDC			
Retransmission	Max.2 channels output	Consumption	Maximum 20VA (20W)			
Auxiliary power supply	24VDC aux. power supply, max. 100mA	Insulation	Power to ground (housing) > 1500VAC			
Communication	RS485 Standard MODBUS-RTU protocol	Case material	ABS case, Acrylic front panel			
Printing	RS232 printing port	Mounting	Panel flush mounting			
Flow totalize	With Temperature, pressure compensation	Size/Net Weight	96X96X100mm/0.8KG			
Math	+,-, x,/, mini, max, average	Working ambient	T: 0-50 deg CH: 10%-85 % (No dew)			

Output Specification

Relay Output		Flow Totalize	
Output No.	Max. 2 outputs	Display Type	Flow rate, Flow totalize, batch totalize
Relay type	NO; 220VAC/30VDC/3A	Flow rate	-20000 to 20000, 5 digits
Output type	programmable, Individual output per channel or Common output for all channel,	Flow Totalize	0.0 to 2000000000.0, 11digits
Alarming type	HA, HHA, LA, LLA, DIFF. per channel	Batch Totalize	0.0 to 200000000.0, 10digits
Alarming display	HA, HHA, LA, LLA will be flashing when alarming occurs in screens	Decimal no.	Flow rate: 0-4, programable
Communication output			Totalizer: 1-5, programable
Output Type	RS485 serial port output	Compensation	Temperature, pressure compensation
Isolation	Photoelectrical isolated	Com. Type	superheating steam, saturated steam, gas linear pressure, linear temperature
Function	read and write the data and parameter	Square root	Off, different pressure on
Protocol	Standard MODBUS-RTU protocol		different pressure off
Baud rate	4800, 9600, 19200	Engineer unit	Flow rate: Kg/h, kg/s, t/h, M3/hr.....
Address	0-253, programmable		Flow totalize: kg, t, m3....
Cable	RS485 shielded twisted pair cable		Batch totalize: kg, t, m3....
Retransmission output		Math	
Output no.	Max.2 channels output	Channel no.	1-8 channels
	4-20mA, 2 wire	Math type	Plus.: +, Minus: -, multiply, division: ÷
Output type	4-20mA default; 0-10mA		Average, Max. Min.
Type	2 wire output	Decimal No.	0-4, programmable
Printing Function		Polyline Math	
Output Type	RS232 printing port	Function	Used for value polyline offset
Data Type	History data in digital or curve	Channel no.	1-8 channels
Resolution	240dots/line	Polyline no.	0-6, programmable
Interval time	1-30000 seconds, programmable	Range	-20000 to 20000
Printing time	Programmable as required	Decimal no.	0-4, programmable
Printer		PC software	
Type	Dot Matrix, Ribbon mini printer	PC version	Window 2000/XP, VISTA, Win7, 8, 10
Resolution	96dots/line,	PC hardware	30MB or more
	144dots/line,	Installation	Please copy it to your PC directly
	240dots/line	PC software	free, Used when USB drive data transfer
size	122.6x66.6x73mm	Functions	Display the history data in digital and curve
Cut size	103mm(W)x57mm(H)x65mm(D)		Export the data as excel formal further
Net Weight	1kg		Print the history data in curve by printer
Paper Width	44mm/57mm		Flow totalize display in shift, week, month
Print Width	32mm/48mm	DCS software	Used for RS485 communication, option
Power supply	5VDC,1.5A	Functions	Real time reading, monitoring while memory

Order Code

MPR800 Color paperless recorder, 96x96x110mm								Description
MPR800	-X	-X		-X	-X	-X	-X	MPR800 universal paperless recorder, 96x96x110mm
Channels No.	-01							1 channels input
	-02							2 channels input
	-03							3 channels input
	-04							4 channels input
	-05							5 channels input
	-06							6 channels input
	-07							7 channels input
	-08							8 channels input
Frequency Input								None
	-F1							Frequency Input, 1 Channel,0-5KHZ
	-F1H							Frequency Input, 1 Channel,0-500HZ
	-F1N							Frequency Input, 1 Channel,0-50HZ
Communication Output								None
	-C1							photoelectric- isolated RS485 output, MODBUS-RTU
Flow Totalize, Math Function								None
	-F							Flow totalize ,Math Function
OUT1								None
	-NO							Relay alarm output: NO ,30VDC/3A, 220VAC/3A
OUT2								None
	-NO							Relay alarm output: NO ,30VDC/3A, 220VAC/3A
	-P3							Isolated auxiliary 24VDC power supply for transmitter, sensor and another device, max.40mA
	-P							RS232 Printing port for mini printer
	-T							Isolated 4-20mA retransmission output
Retransmission output (When input channels ≤5 channels)								None
	T							1 channel Isolated 4-20mA retransmission output
	2T							2 channel Isolated 4-20ma retransmission output
Power Supply							-N	100-240VAC
							-D	24VDC

Note:

- Order Code: E.g.: MPR800-06 -C1-F-NO-N: universal color paperless recorder, 6 channels, NO, 3A, RS485 communication output, 100-240VAC, Flow totalizer, math Function, 100-240VAC, USB data transferring and PC software.
- Relay output can be as alarm output, also as simple on-off output.
- Here 1 channel frequency input is included in 16 channels, MPR800 max. 16 channels input. Please advise me the frequency input range or pulse input range when frequency input ordered.
- Frequency 0-5KHZ, low frequency :0-50hz, 0-500hz ,e.g: rotation, speed



Xiamen Madincos Automation Co., Ltd

Add.: No. C303, 3rd Floor, Kechuang Building, No.321 Torch Road, Torch Park, Torch High-tech Zone, Xiamen,China

URL: www.madincos.com

Email: info@madincos.com

Mobile:+86-17750003689